

# EZ FLAG

## SPECIFICATIONS & INSTRUCTIONS

### GROUND STAKE INSTRUCTIONS

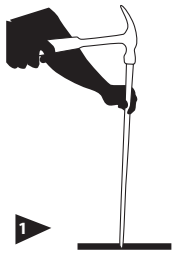

**1**  
Pound ground stake at least 12" into the ground.

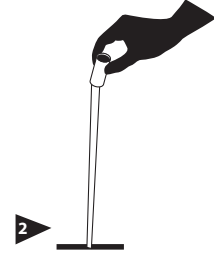

**2**  
Slide the EZ Glide collar over top the ground stake.

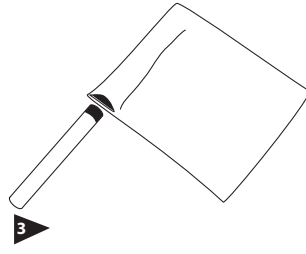

**3**  
Assemble the side pole and insert it into the sleeve on the left of the graphic, then slide the top pole into the sleeve on the top of the graphic.

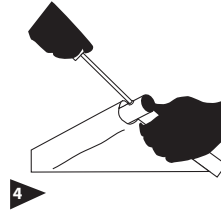

**4**  
Screw the two poles together.

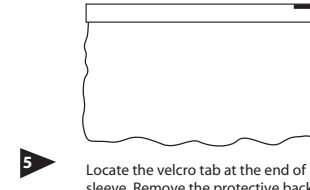

**5**  
Locate the velcro tab at the end of the sleeve. Remove the protective backing and apply the adhesive layer directly to the pole. (Note: When disassembling flag, simply unzip velcro pieces from each other.)

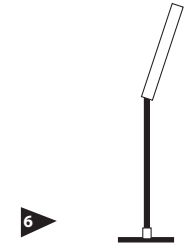

**6**  
Place the EZ Flag over the ground stake.

### HARD SURFACE STAND INSTRUCTIONS

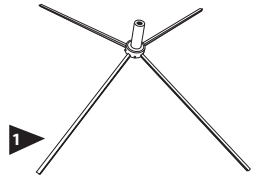

**1**  
Place the hard surface stand in the desired location

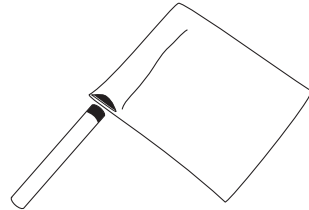

**2**  
Assemble the side pole and insert it into the sleeve on the left of the graphic, then slide the top pole into the sleeve on the top of the graphic.

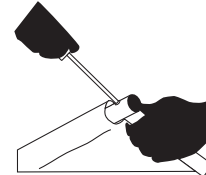

**3**  
Screw the two poles together.

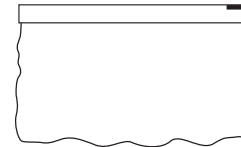

**4**  
Locate the velcro tab at the end of the sleeve. Remove the protective backing and apply the adhesive layer directly to the pole. (Note: When disassembling flag, simply unzip velcro pieces from each other.)

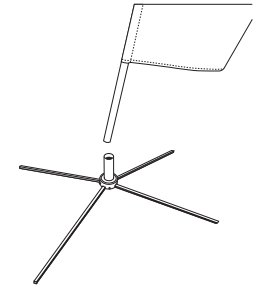

**5**  
Place the EZ Flag over the post on the hard surface stand.

### SPECIFICATIONS

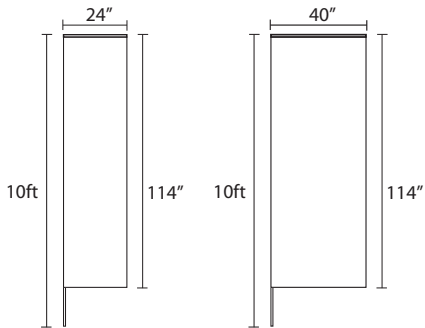

Viewable area  
23"W x 111.5"H

Viewable area  
40"W x 114"H

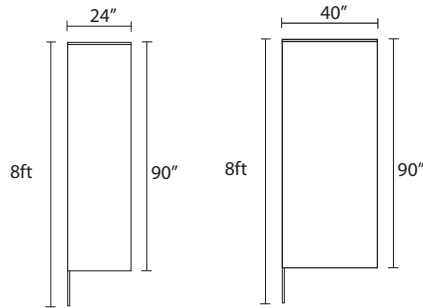

Viewable area  
24"W x 90"H

Viewable area  
40"W x 90"H

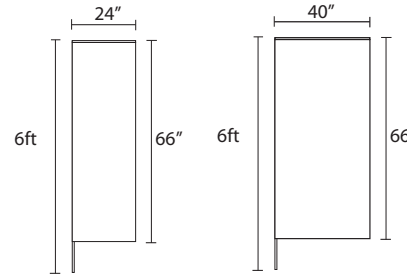

Viewable area  
24"W x 66"H

Viewable area  
40"W x 66"H

### PARTS:

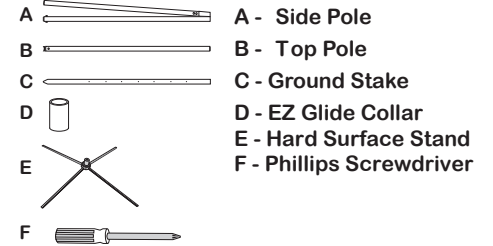

### NOTES:

- Refer to the graphic templates for art layout sizes.
- Custom Sizes are available.
- Critical art and text should not be within 2" of the sides and 1.5" of the top and bottom of the viewable area.
- See "Preparing Digital Files" for specific details on submitting art.